

Central Article Code:

Local Code:

BMFS 185

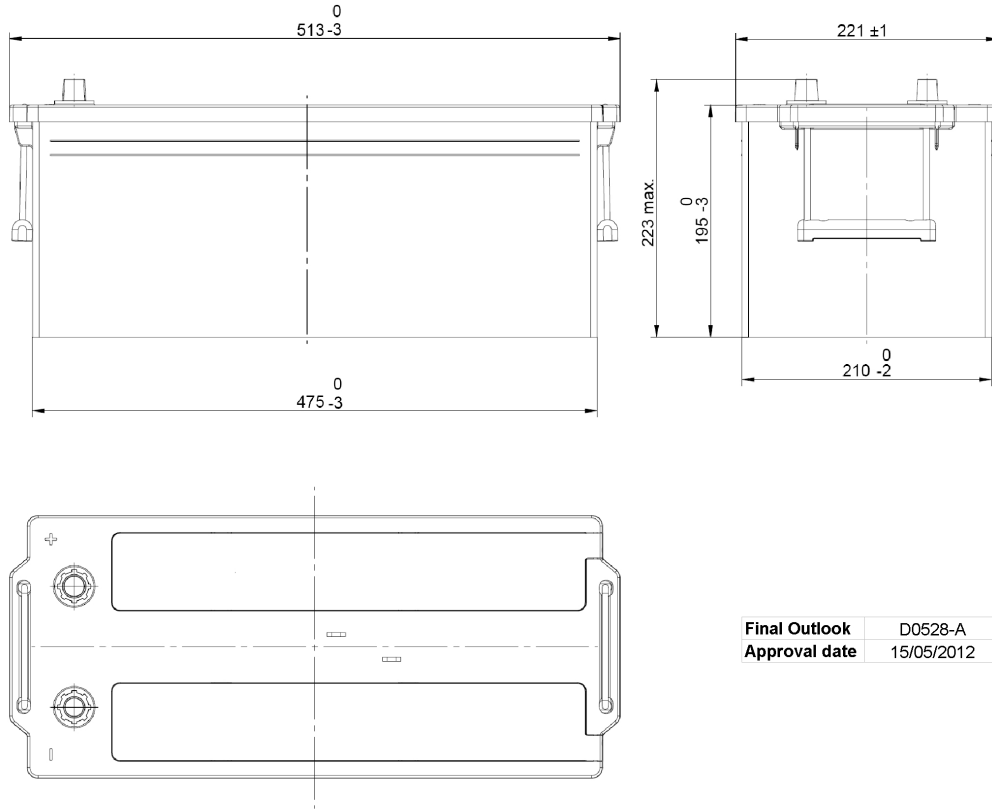

Final Outlook	D0528-A
Approval date	15/05/2012

PERFORMANCES

Voltage (V):	12 V	
C20 (Ah):	185.0	20 h
Cranking (A):	1150	EN
Charge:	WET	
Technology:	Vented/Flooded	
Grid:	Ca/Ca	

STD. DIMENSIONS

Length (mm ± 2):	513
Width (mm ± 2):	223
Height (mm ± 2):	223
Total Weight (kg ± 5%):	43.90

CONTAINER

Type:	D05	GREY MEDIUM
Hold Down:	B0	
H.D. Adapter:	No	

COVER

Type:	Flat/Press	GREY MEDIUM
Polarity:	ETN 3	
Terminals:	EN taper post	
Terminal Adapter:	No	
SOCI:	No	
Ventilation:	Central	
Filter:	1 Filter per Vent	
Lateral Plug:	No	

PLUGS

Type:	2 x VCL Vent	GREY MEDIUM
-------	--------------	-------------

HANDLES

Type:	2 x Rope (Rigid holde	BLACK
-------	-----------------------	-------

OTHERS

Degassing Tube:	No
-----------------	----