

Specifications

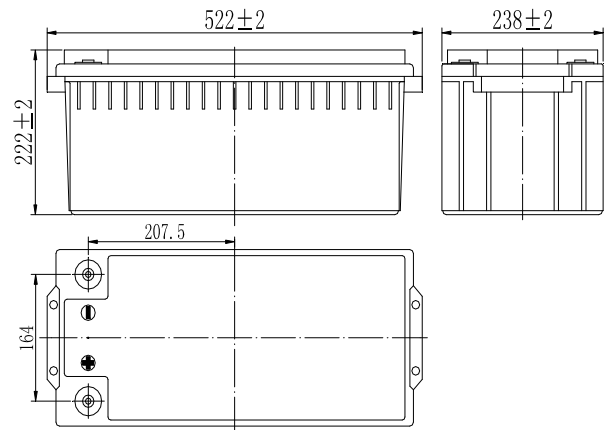

Nominal Voltage		12 V
Capacity (25°C)	20HR(10.5V)	225 Ah
	5HR(10.2V)	176 Ah
	1HR(9.6V)	136Ah
Dimension	Length	522 ± 2mm (20.55inch)
	Width	238 ± 2mm (9.37inch)
	Height	222 ± 2mm (8.74inch)
	Total Height	222 ± 2mm (8.74inch)
Approx. Weight		63,5 kg (143.2lbs) ± 4%
Terminal type		T11
Internal resistance (Fully charged, 25°C)		Approx. 3.3m Ω
Capacity affected by temperature (10HR)	40°C	103%
	25°C	100%
	0°C	88%
	-15°C	70%
Self-discharge (25°C)	3 month	Remaining Capacity: 94%
	6 month	Remaining Capacity: 88%
	12 month	Remaining Capacity: 75%
Nominal operating temperature		25°C ± 3°C (77°F ± 5°F)
Operating temperature range	Discharge	-15°C ~ 50°C (5°F ~ 131°F)
	Charge	-10°C ~ 50°C (14°F ~ 131°F)
	Storage	-20°C ~ 50°C (-4°F ~ 131°F)
Float charging voltage(25°C)		13.50 to 13.80V Temperature compensation: -18mV/°C
Cyclic charging voltage(25°C)		14.10 to 14.40V Temperature compensation: -30mV/°C
Maximum charging current		40A
Terminal material		Copper
Maximum discharge current		1600A(5 sec.)
Designed floating life(20°C)		15 years

Dimensions



Terminal

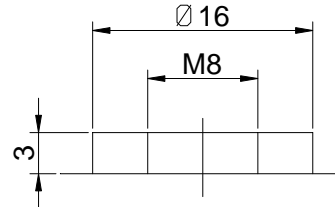

Terminal T11

- ◆ Gelled electrolyte technology;
- ◆ PVC separator;
- ◆ Recognized by UL & CE;
- ◆ ABS container.

Constant Current Discharge Characteristics (A, 25°C)

F.V/TIME	15min	30min	60min	2h	3h	4h	5h	6h	8h	10h	20h	48h	120h
9.60V	270	186	116	68.0	48.0	37.8	31.6	27.0	21.0	18.7	10.2	---	---
9.90V	264	183	115	67.6	47.6	37.6	31.4	26.8	20.8	18.7	10.2	---	---
10.2V	254	177	112	67.0	47.4	37.2	31.2	26.6	20.8	18.6	10.2	4.46	---
10.5V	246	173	110	66.0	47.0	37.0	31.0	26.4	20.6	18.5	10.0	4.43	1.84
10.8V	232	166	106	64.4	45.6	35.8	30.0	25.6	20.0	18.4	10.0	4.43	1.84

Constant Power Discharge Characteristics (Watt, 25°C)

F.V/TIME	15min	30min	60min	2h	3h	4h	5h	6h	8h	10h	20h	48h	120h
9.60V	3014	2124	1340	792	566	446	376	320	250	224	123	---	---
9.90V	2940	2082	1320	786	564	444	374	318	250	224	123	---	---
10.2V	2832	2018	1288	780	560	440	370	316	248	224	123	53.5	---
10.5V	2736	1970	1262	768	556	438	368	314	246	222	121	53.2	22.2
10.8V	2592	1898	1222	748	538	424	358	304	238	220	121	53.2	22.0

Note: The above characteristics data can be obtained within three charge/discharge cycles.

Discharge Characteristics(25°C)

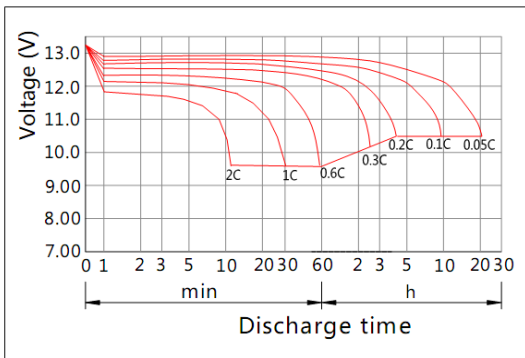

Charging Characteristics(25°C)

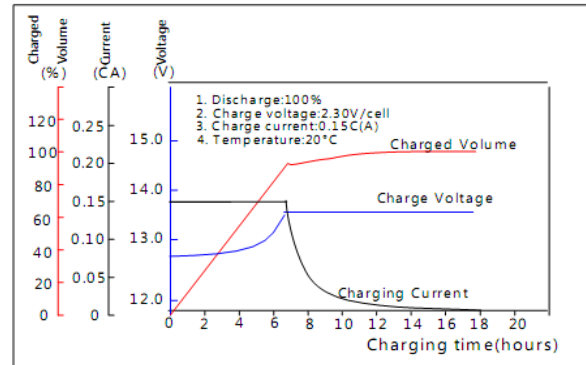

Effect of Temperature on Capacity

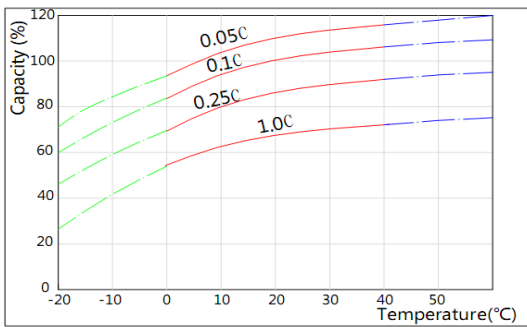

Self-discharge Characteristics

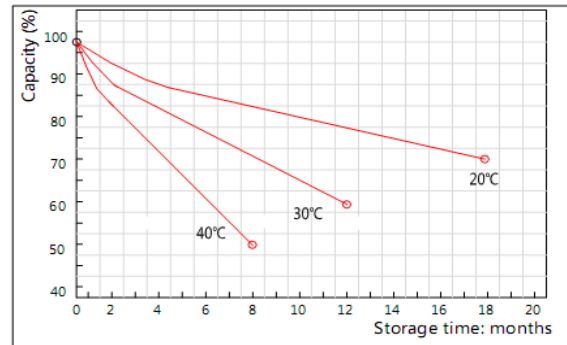

The Relationship for Open Circuit Voltage and Residual Capacity (25°C)

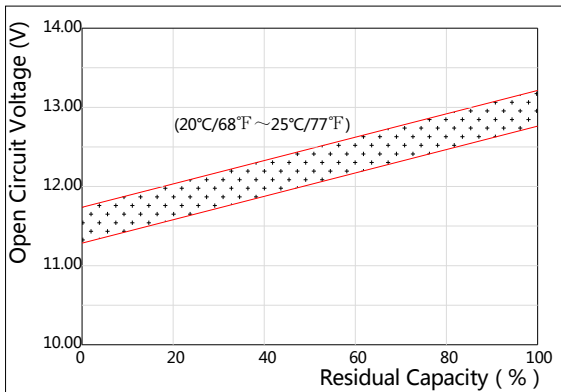

The Relationship for Charging Voltage and Temperature

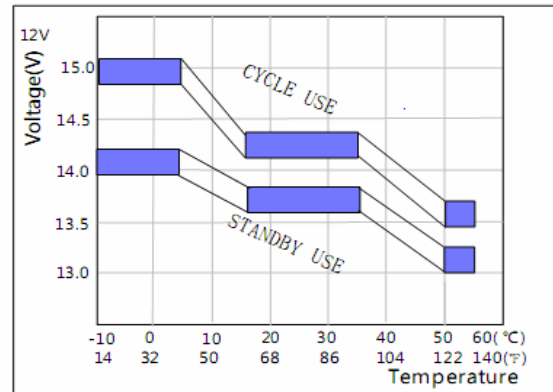

Floating Life on Temperature

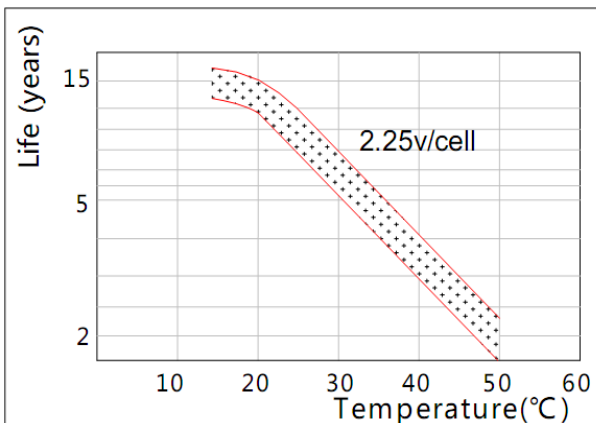

Cycle Life on D.O.D(25°C)

