

Specifications

Nominal Voltage		12 V
Capacity (25°C)	20HR(10.5V)	260 Ah
	5HR(10.2V)	205Ah
	1HR(9.6V)	155Ah
Dimension	Length	521 ± 2mm (20.51inch)
	Width	269 ± 2mm (10.59inch)
	Height	220 ± 2mm (8.66inch)
	Total Height	220 ± 2mm (8.66inch)
Approx. Weight		67 kg (144.9lbs) ± 4%
Terminal type		T11
Internal resistance (Fully charged, 25°C)		Approx. 2.9m Ω
Capacity affected by temperature (10HR)	40°C	103%
	25°C	100%
	0°C	88%
	-15°C	70%
Self-discharge (25°C)	3 month	Remaining Capacity: 94%
	6 month	Remaining Capacity: 88%
	12 month	Remaining Capacity: 75%
Nominal operating temperature		25°C ± 3°C (77°F ± 5°F)
Operating temperature range	Discharge	-15°C ~ 50°C (5°F ~ 131°F)
	Charge	-10°C ~ 50°C (14°F ~ 131°F)
	Storage	-20°C ~ 50°C (-4°F ~ 131°F)
Float charging voltage(25°C)		13.50 to 13.80V Temperature compensation: -18mV/°C
Cyclic charging voltage(25°C)		14.10 to 14.40V Temperature compensation: -30mV/°C
Maximum charging current		50A
Terminal material		Copper
Maximum discharge current		2500A(5 sec.)
Designed floating life(20°C)		15 years

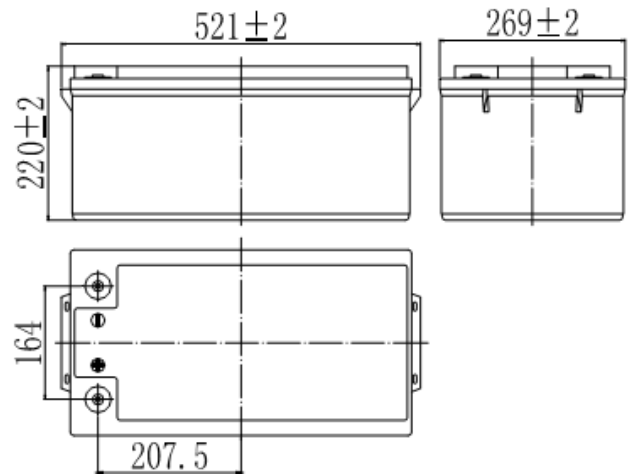

Dimensions



Terminal

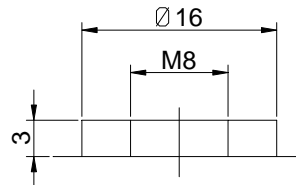

Terminal T11

- ◆ Gelled electrolyte technology;
- ◆ PVC separator;
- ◆ Recognized by UL & CE;
- ◆ ABS container.

Constant Current Discharge Characteristics (A, 25°C)

F.V/TIME	15min	30min	60min	2h	3h	4h	5h	6h	8h	10h	20h	48h	120h
9.60V	338	233	145	85.0	60.0	47.3	39.5	33.8	26.3	23.4	12.8	---	---
9.90V	330	229	144	84.5	59.5	47.0	39.3	33.5	26.0	23.4	12.8	---	---
10.2V	318	221	140	83.8	59.3	46.5	39.0	33.3	26.0	23.3	12.8	5.58	---
10.5V	308	216	138	82.5	58.8	46.3	38.8	33.0	25.8	23.1	12.5	5.54	2.30
10.8V	290	208	133	80.5	57.0	44.8	37.5	32.0	25.0	23.0	12.5	5.54	2.30

Constant Power Discharge Characteristics (Watt, 25°C)

F.V/TIME	15min	30min	60min	2h	3h	4h	5h	6h	8h	10h	20h	48h	120h
9.60V	3768	2655	1675	990	708	558	470	400	313	280	154	---	---
9.90V	3675	2603	1650	983	705	555	468	398	313	280	154	---	---
10.2V	3540	2523	1610	975	700	550	463	395	310	280	154	66.9	---
10.5V	3420	2463	1578	960	695	548	460	393	308	278	151	66.5	27.8
10.8V	3240	2373	1528	935	673	530	448	380	298	275	151	66.5	27.5

Note: The above characteristics data can be obtained within three charge/discharge cycles.

Discharge Characteristics(25°C)

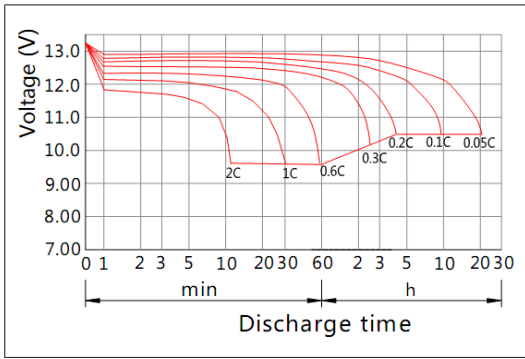

Charging Characteristics(25°C)

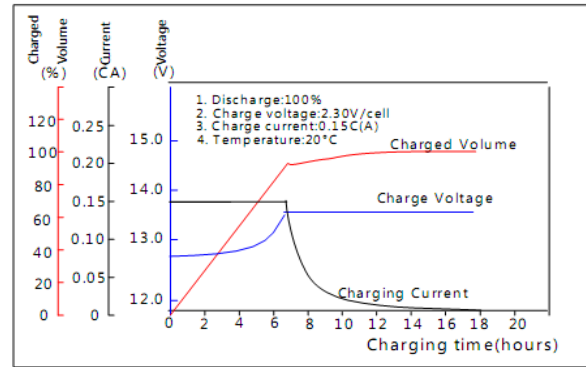

Effect of Temperature on Capacity

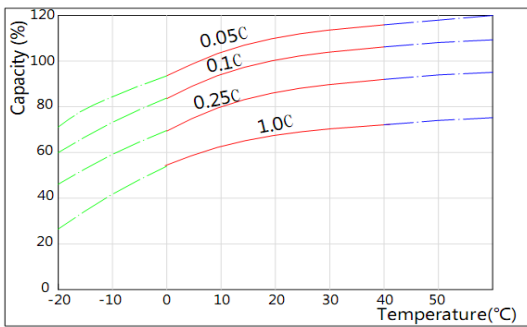

Self-discharge Characteristics

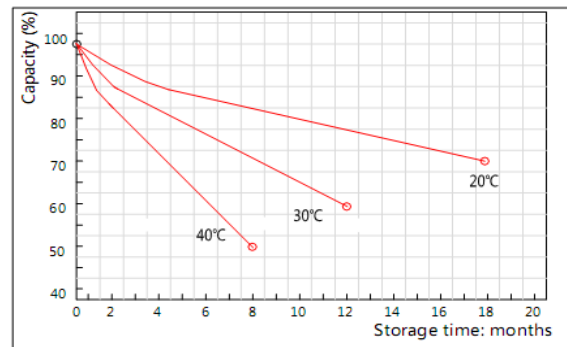

The Relationship for Open Circuit Voltage and Residual Capacity (25°C)

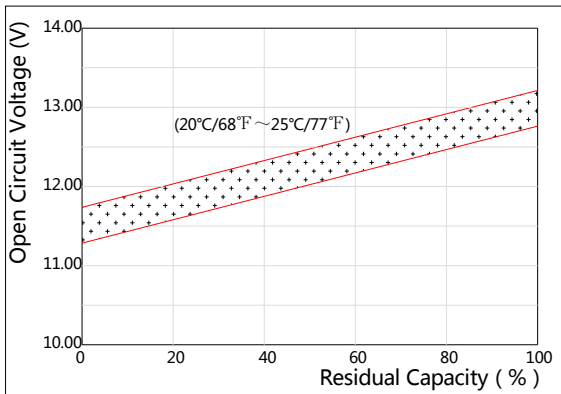

The Relationship for Charging Voltage and Temperature

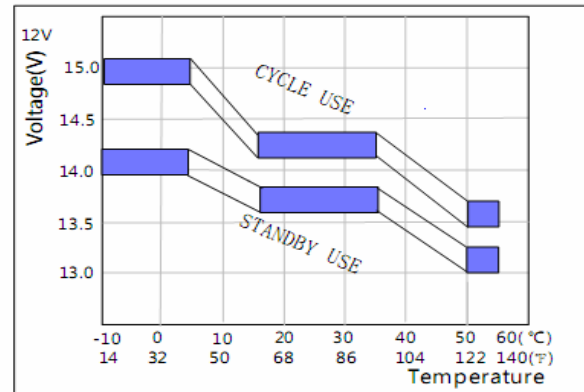

Floating Life on Temperature

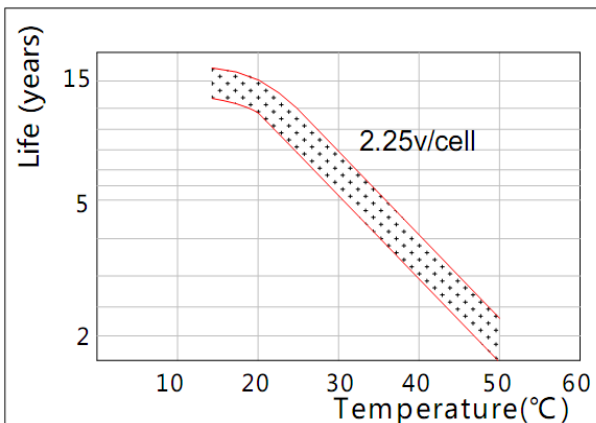

Cycle Life on D.O.D(25°C)

