

Specifications



Nominal Voltage		6 V
Capacity (25°C)	20HR(5.25V)	225 Ah
	5HR(5.10V)	200Ah
	1HR(4.80V)	132Ah
Dimension	Length	243 ± 2mm (9.57inch)
	Width	187 ± 2mm (7.36inch)
	Height	253 ± 2mm (9.96inch)
	Total Height	276 ± 2mm (64.9inch)
Approx. Weight		32kg (68.5lbs) ± 4%
Terminal type		T9
Internal resistance (Fully charged, 25°C)		Approx. 2.2m Ω
Capacity affected by temperature (10HR)	40°C	103%
	25°C	100%
	0°C	88%
	-15°C	70%
Self-discharge (25°C)	3 month	Remaining Capacity: 94%
	6 month	Remaining Capacity: 88%
	12 month	Remaining Capacity: 75%
Nominal operating temperature		25°C ± 3°C (77°F ± 5°F)
Operating temperature range	Discharge	-15°C ~ 55°C (5°F ~ 131°F)
	Charge	-10°C ~ 55°C (14°F ~ 131°F)
	Storage	-20°C ~ 55°C (-4°F ~ 131°F)
Float charging voltage(25°C)		6.76 to 6.90V Temperature compensation: -9mV/°C
Cyclic charging voltage(25°C)		7.05 to 7.20V Temperature compensation: -15mV/°C
Maximum charging current		38A
Terminal material		Copper
Maximum discharge current		1900A(5 sec.)
Designed floating life(20°C)		15 years

- ◆ Gelled electrolyte technology;
- ◆ PVC separator;
- ◆ Recognized by UL & CE;
- ◆ ABS container.

Constant Current Discharge Characteristics (A, 25°C)

F.V/TIME	15min	30min	60min	2h	3h	4h	5h	6h	8h	10h	20h	48h	120h
4.80V	257	177	111	64.6	45.6	35.9	30.0	25.7	20.0	17.8	9.71	---	---
4.95V	251	173	109	64.2	45.2	35.7	29.8	25.5	19.8	17.8	9.69	---	---
5.10V	241	168	106	63.7	45.0	35.3	29.6	25.3	19.8	17.7	9.61	4.24	---
5.25V	234	164	104	62.7	44.7	35.2	29.5	25.1	19.6	17.6	9.50	4.22	1.75
5.40V	220	158	101	61.2	43.3	34.0	28.5	24.3	19.0	17.5	9.50	4.22	1.75

Constant Power Discharge Characteristics (Watt, 25°C)

F.V/TIME	15min	30min	60min	2h	3h	4h	5h	6h	8h	10h	20h	48h	120h
4.80V	1433	1009	637	376	270	213	179	152	119	107	58.5	---	---
4.95V	1397	990	627	374	268	211	178	151	119	106	58.5	---	---
5.10V	1345	960	612	371	266	209	176	150	118	106	58.3	25.5	---
5.25V	1300	937	600	365	264	209	175	149	117	105	57.4	25.3	10.5
5.40V	1231	903	581	355	257	201	170	144	113	105	57.6	25.3	10.5

Note: The above characteristics data can be obtained within three charge/discharge cycles.

Dimensions

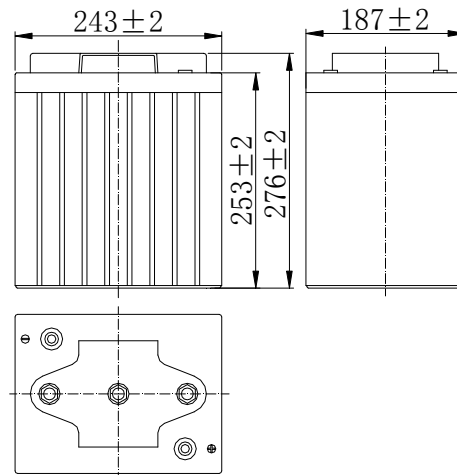

Terminal

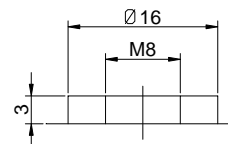

Terminal T11

Discharge Characteristics(25°C)

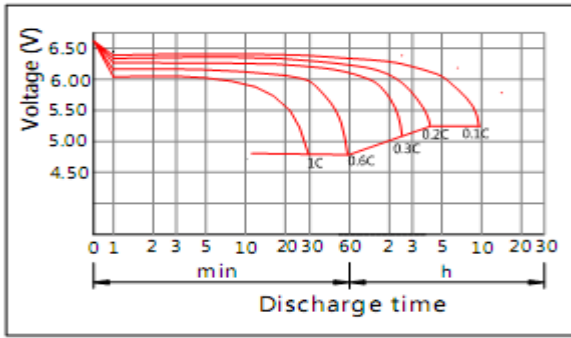

Charging Characteristics(25°C)

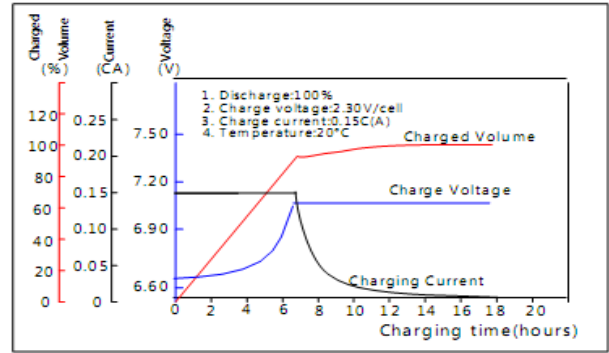

Effect of Temperature on Capacity

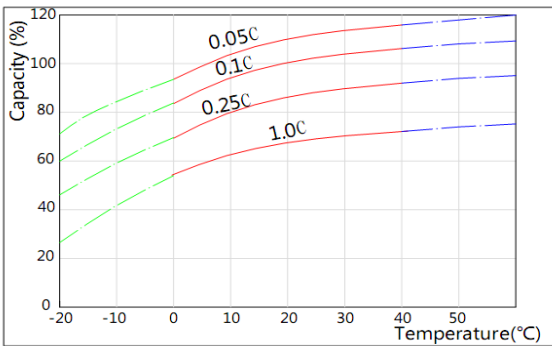

Self-discharge Characteristics

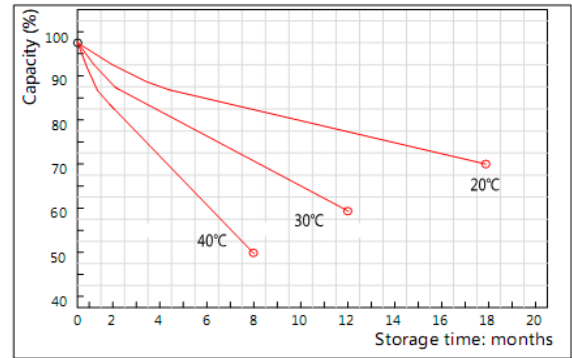

The Relationship for Open Circuit Voltage and Residual Capacity (25°C)

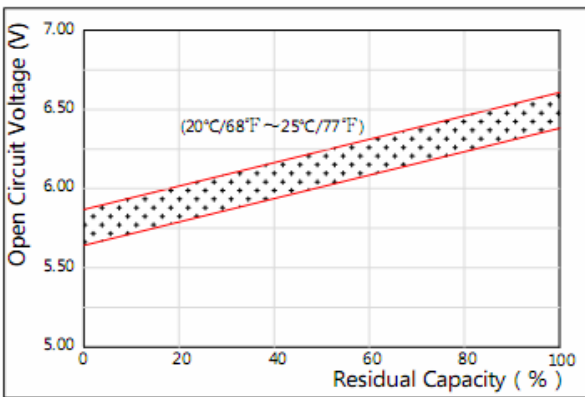

The Relationship for Charging Voltage and Temperature

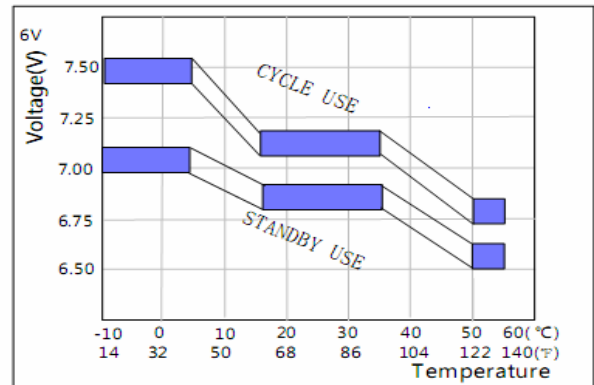

Floating Life on Temperature

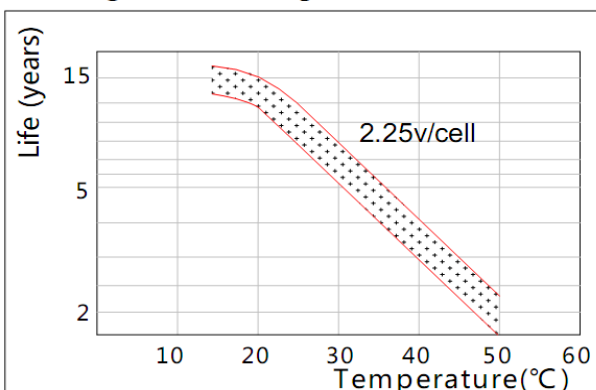

Cycle Life on D.O.D(25°C)

